

Diritti riservati

All rights reserved

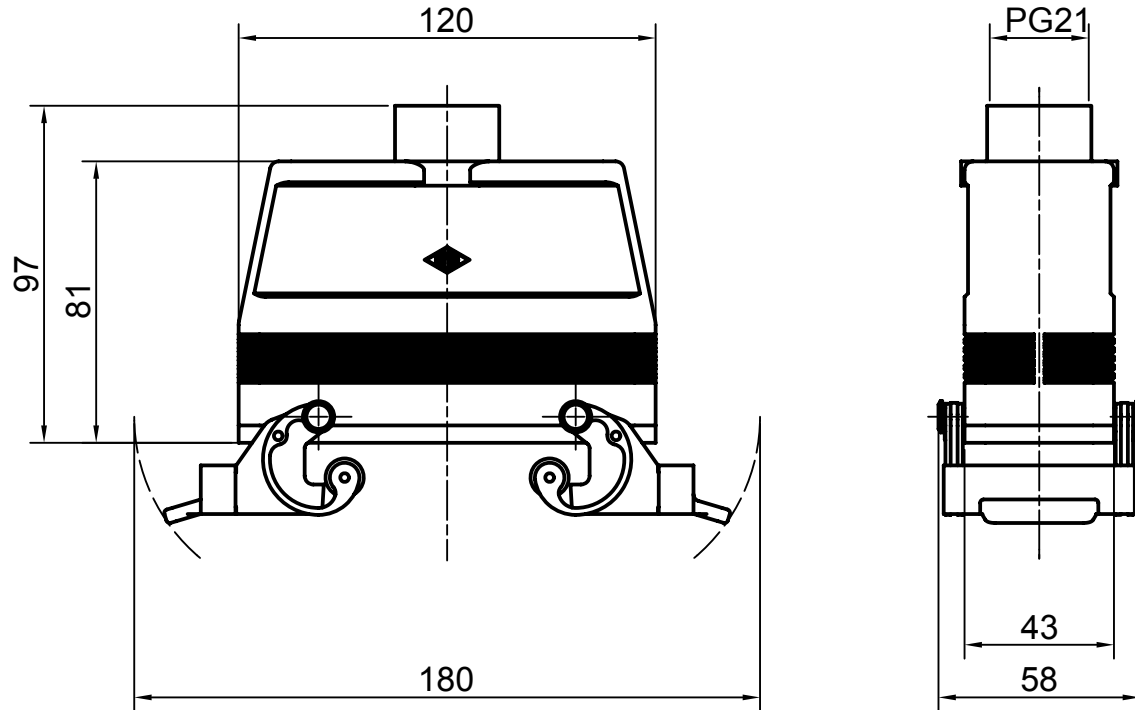

Date 04.01.2007	CMAV 16 G		Scale
Sign.	hood top entry with 2 lev. PG21 ins.		1:2
			